

BSL MAGIC ZOOM 19

USERS GUIDE

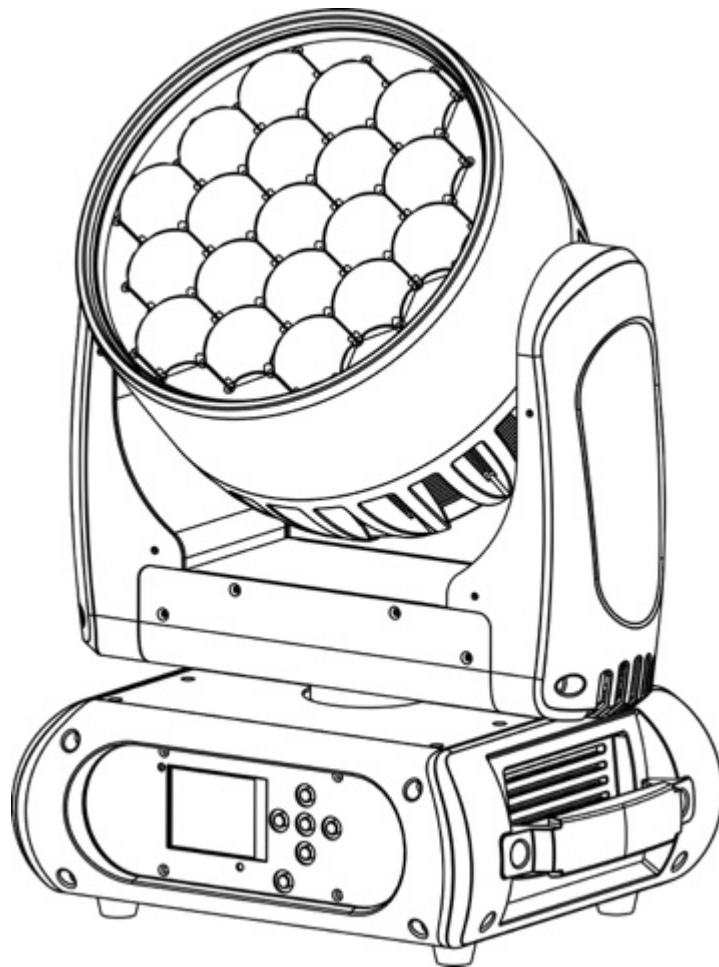

CE

1. Product Introduction:

1.1 Before unpack the fixture, pls make sure that the packing is in good condition, following items will be found in the box:

- The fixture
- This users guide
- 3m DMX cable
- 1.5m power cable with powercon
- Omega bracket for hanging installation
- Safety chain

1.2 Specification

Source

- Light source: 19pcs OSRAM 15W 4in1 leds, PIXEL control
- Led life: 60.000 hours
- Luminous Flux: 8000lumen, 21880lux@3m at 6°, 1600lux@3m at 65°
- Control: Remote on/off via DMX
- Ballast: switching mode power supply

Optical System

- Beam angle: 6° to 65°

X/Y

- Pan: 630° (2.2.0 sec) or 540°(2.0 sec), Tilt: 265° (0.85 sec)
- 16-bit resolution
- Auto repositioning

Features

- DMX channels: 19/98/18/20
- Super fast, smooth and silent movement
- Pixel control of every single led on RGBW separately
- Nice mapping effect with dimming and color fading at the same time
- RGBW four colors mixing to create vivid, saturated and uniform color effect
- Pre-set color temperature at 2700K, 3200K, 4200K, 5600K and 8000K
- zoom from 6° to 65°
- Full range 0-100% dimmer
- Various strobe
- RDM function to change DMX address, display flip, X/Y Reverse and so on
- Software upgrade via DMX
- Hibernation when lost DMX for preset time
- Indicate temperature info of base, arm and lamp
- Fan speed auto change according to temperature
- Heat pipe for cooling

Display

- 2.4inch super nice LCD display with friendly English/ Chinese/French/Spanish menu
- Auto lock
- Flip
- Back-up communicating IC
- Pre-set wireless and battery holder

1.3 Description of the Device

1. Project lens
2. Head
3. Arm
4. Base
5. Display
6. Foot stand
7. Operation button
8. Handel

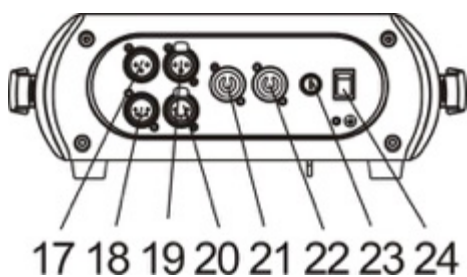
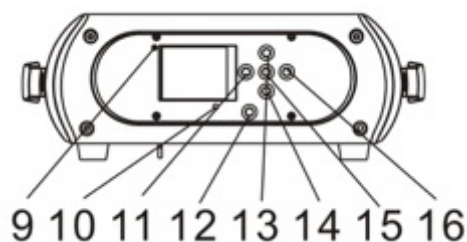
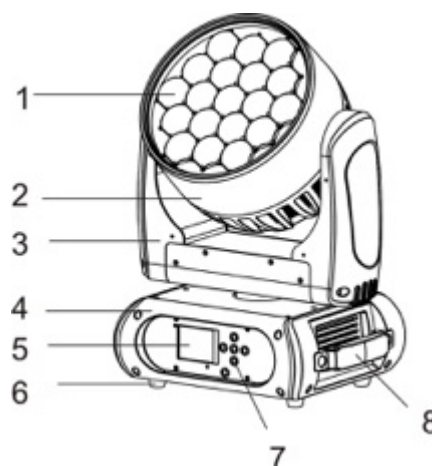













9. Wireless indicator
10. Mic
11. Left button
12. Battery indicator
13. Up button
14. Down button
15. Enter button
16. Right button
17. 3-pin DMX in
18. 5-pin DMX in
19. 3-pin DMX out
20. 5-pin DMX out
21. Powercon in
22. Powercon out
23. Fuse
24. Power switch

2. Safety and maintenance Information

2.1 Safety Info

	<p>Before operate this unit, please carefully read this users guide and keep if needed in future. It's necessary to respect following rules.</p>
	<p>The disposal of the device after lifecycle could damage the environment, need to take it to special company for recycling or return to authorized dealer.</p>

	The products referred to in this manual conform to the European Community Directives and are therefore marked with CE logo.
	Keep this device away from children and unauthorized users, the manufacturer will not take responsibility for the damage due to any disregard of the information provided in this manual and wrong operation.
	Before operate the device, pls make sure the fixture is in good housing, ensure pan and tilt can rotate in its complete range.
 --0.5m 	Pls make sure minimal 0.5m distance need to kept between the fixture to any flammable material.
	The device can only run with 100-240v voltage, 50/60Hz power, don't connect to any other wrong power. Disconnect the device from main power before open the shield or maintenance.
	The device is designed only for indoor usage, pls keep it away from moisture. Do not expose the device under the sun or directly to any other lighting source.
	Never look directly into the projecting lens when the fixture is power on, the light may trigger epileptic seizures in photosensitive persons or persons with epilepsy. Especially at beam effect, extreme caution and observance of these safety instructions is mandatory.
	Don't put or install the device on a surface that subject to vibration or bumps.
Ta=45 °C	The device is supposed to work in the temperate range -15° C and +45° C, do not use the device when the temperate exceed this range.
	The lens, shield need to be replaced when obviously broken, never use the device when the shield is not completed closed.
	Safety I class device, need to be earth connected.
	When the fixture is hanged overhead, the safety rope must be fixed to the bottom of the device to the appropriate fixing point.
	Always carry the device by the handles, do not take the head or arm directly for transportation.

2.2 Maintenance

2.2.1 Operation only allowed to qualified person, damages due to unprofessional operation or remove of any parts inside will not be considered in warranty service. There are no serviceable parts inside the device or package, service only leaves to authorized dealers.

2.2.3 Never allow the optical components contact with oil, fat or any other liquid.

2.2.4 A regular clearance of the device is needed for long-term usage, this is very helpful to maintain the lifetime and brightness need to use a soft and lint-free cloth to clean the optical system, fan and air flowing tunnel.

2.2.5. Trouble Shooting

Problems	Possible reasons	Checking or solutions
Device not power up	Powercon or power cable damaged Faulty power supply	Change a good power cable to try Replace new power supply
Pan/Tilt error or vibrate	Faulty Pan/Tilt PCB Faulty opto sensor Cable loosen	Replace PT001 PCB Replace opto sensor OP001 Check the cable connect to OP001

LED off	Temperature protection Fan not working Faulty LED Dimmer and strobe set at 0 Faulty power supply	Check the temperature from menu Check the fan speed info from menu Replace new LED Set dimmer and strobe channel at 255 Replace new power supply
Device not response to DMX	Faulty communication IC Faulty display PCB Wrong DMX addressing Faulty DMX cable	Replace the IC with back-up one in the display PCB Replace new display PCB Check the address and setting Change to a good DMX cable

2.2.6 Replacement of the fuse

Need to replace with same type and rating, which originally installed in the device.

Step One: Unplug power cable from main power.

Step Two: Unscrew the fuse holder out of the housing with a screwdriver.

Step Three: Remove the broken fuse and replace with an exact same type of new fuse.

Step Four: Insert the fuse holder back to the housing and screw tight and reconnect power.

3. Installation

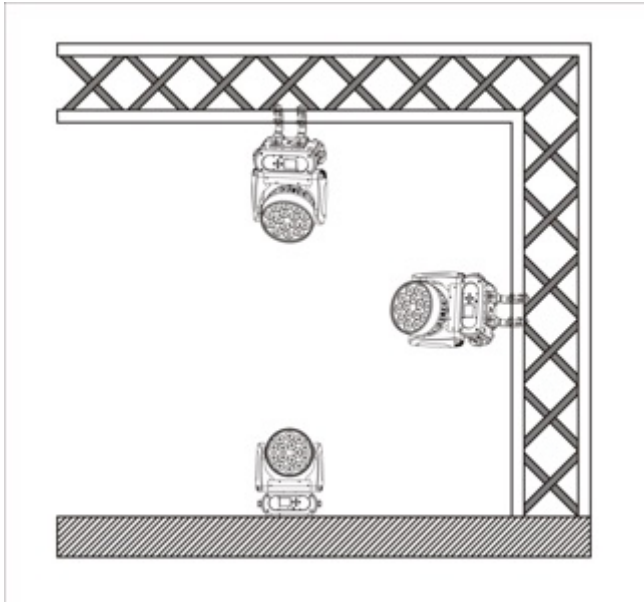

3.3 How to do mounting installation.

3.1 The device could be either put on a solid and even surface, or mounted upside down or sideways like left picture.

3.2 The mounting place must be sufficient stable and be able to support a weight of 10 times of the unit's weight. When the fixture is hanged, always additionally secure the device with the safety chain, fasten the safety rope at a suitable position so that the maximum fall of the projector will be 20 cm

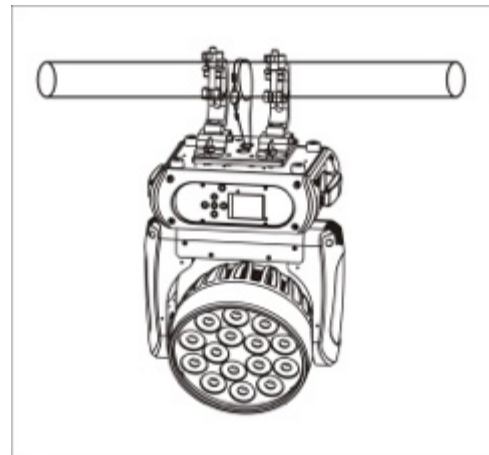
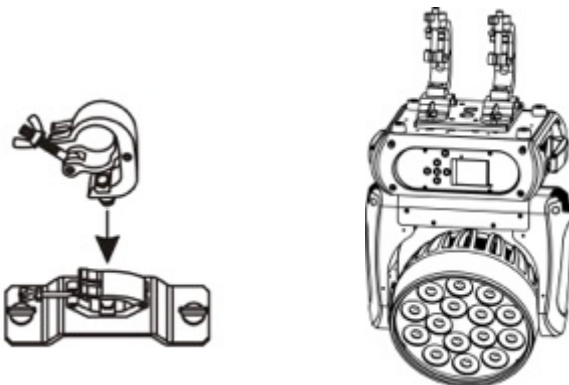

Step one: Installation the clamp onto the omega bracket;

Step two: Install the clamp and bracket on the bottom of panel, fasten the quick-locks;

Step three: Install the whole device onto appropriate truss and fasten the clamps, tight the safety rope with the truss or other fixing point at a suitable position that drop down distance not exceed 20 cm.

4. Control menu

4.1 Meaning of the icon in menu

CONNECT	LIGHT	INFOMATION	SET	PROGRAM
				

4.2 Menu tree

Default setting shadowed. mark with ① can be basic reloaded, ② be program reloaded, ③ can be private reloaded.

Connect	DMX Address①	XXX		DMX address setting
	Wireless①			Wireless Enabled
Light	Max Temperature①	80~139°C, 90°C / 176~282°F, 194°F		Lamp off if temperature continuously over for 5 minutes
	Lamp Adjust①	PAN.....		Adjust value of each channels
Information	Time Info.	Current XXXX(Hours) Fixture Life XXXX(Hours)		Fixture boot time Fixture total run time
	Temperature	Near Lamp Temp (depends on fixture)		Temperature Sensors
	Fans Speed	Near Lamp Fan (depends on fixture)		Fan speed Sensors
	Channel Value	PAN.....		Display value of channel
	Error Message	Pan,Tilt.....		Error channels
	Fixture Model	xxxxxxxxxxxx		Display model brand and model
Set	Software Ver	1U01 V1.0.00 2U01 V1.0.00 :		Version of each IC
	Reset	All Pan&Tilt Others		Reset all Reset Pan&Tilt Reset Others
	Movment	Pan Reverse① Tilt Reverse① Pan Degree① Encoders① Pan/Tilt Mode①	ON/OFF ON/OFF 630/540 ON/OFF Stand/Smooth	Pan Reverse Tilt Reverse Choose Pan Degree Encoder wheel on/off Choose pan/tilt mode
UI Set	Mic Sens. ③ No Signal① Temperature. C/F① Fans Mode① Hibernation① Backlight①	0~99%,60% Close/Hold/Auto/Music Fahrenheit /Celsius Auto Speed /High Speed OFF, 01M~99M, 15M 02~60m 02m	Sensitivity of Mic Mode when no signal Temperature at °C/°F Fans mode Sleeping mode Show backlight time	

		Flip Display ^① Display Bright ^③ Brand Show ^① Key Lock ^① Language ^①	ON/OFF 00~31 10 ON/OFF ON/OFF En/簡/繁/Fr/Sp	Display 180° reverse Display Brightness Show brand or not Key lock on/off Language Select
	Users	User Mode ^①	Standard Extended Basic-8bit Basic-16bit User	Standard mode Extended mode Basic-8bit mode Basic-16bit mode User program mode
		Edit User ^③	Max Channel = XX PAN = CH01 :	Edit users mode
	Calibration ^③	-Password- Pan..	=XXX =XXX	Password: 050 Calibrate channel value
	Fixture ID ^③	Name -Password- PID Code		Name Password: 050 Set PID of RDM
	Wireless Set ^①	DMX On Cable Reset Connect	ON/OFF ON/OFF	DMX Send Out Reset Connect
	Reload Default	Basic Reload ^① Program Reload ^② ---Password--- Private Reload ^③ All Reload	ON/OFF ON/OFF XXX ON/OFF ON/OFF	Basic Reload Program Reload Password: 050 Private Reload All Reload
Program	Play ^①	DMX Receive Slave Receive Sequence Music	Slave Receive 1,2,3 Master / Alone Master / Alone	DMX Receive Choose slave position Run Sequence Music mode
	Select Chase ^②	Chase Part 1 Chase Part 2 Chase Part 3	Chase 1 ~ 8 Chase 1 Chase 1 ~ 8 Chase 2 Chase 1 ~ 8 Chase 3	Select and run auto program
	Edit Chase ^②	Chase 1 : Chase 8	Chase Test Step 01 =SCxxx Step 64 =SCxxx	Test Beginning scene Ending scene
	Edit Scenes ^②	Edit Scene 001 ~ Edit Scene 250	Pan,Tilt,..... =xxx --Fade Time-- =xxx --Secne Time-- =xxx DMX Input	Input manual scene Modify manually fading time Modify manually scene time Input scene from exterior controller
	Scenes Record	ScXX=>ScXX		Auto Input scenes

5. DMX connection and DMX protocol

5.1 DMX addressing:

5.1.1 The device is controlled by universal DMX 512 protocol, DMX address is the start channel used to receive instructions from the external controller. For independent control, each fixture must be assigned its unique address control channels. For example, this device has four channel modes: 19/98/18/20, if we set the mode at standard 19

channels mode, and there are several models need to be independently controlled, we just simply address first fixture at 1, and second fixture at 20, third one at 39, etc.

If the devices have the same address, they will behave synchronically.

DMX addressing is limited, don't set the address so high that without enough control channels for the fixtures.

Display is flashing when no DMX signal is received.

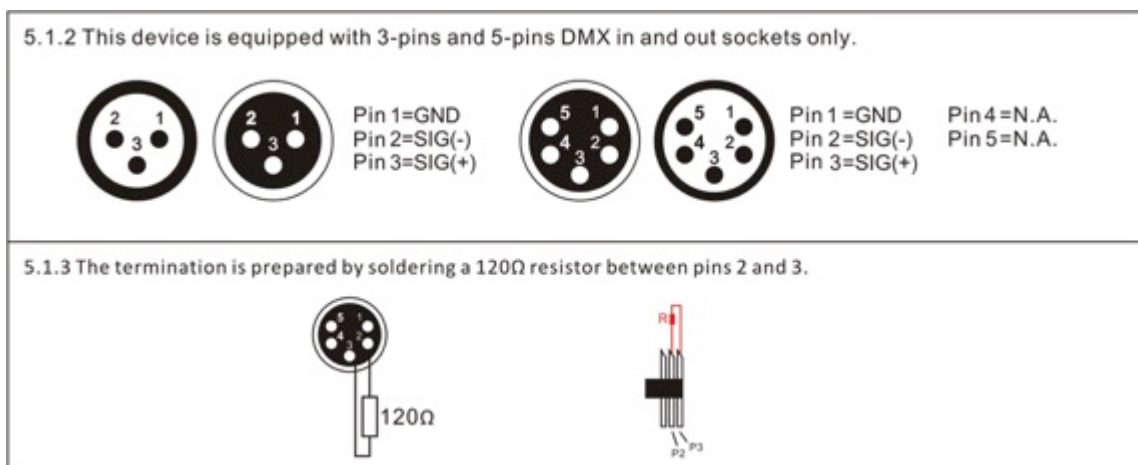

5.1.4 Connection: use DMX cable with 3+5 pin XLR-plugs to connect the controller with the fixture or one fixture with another.

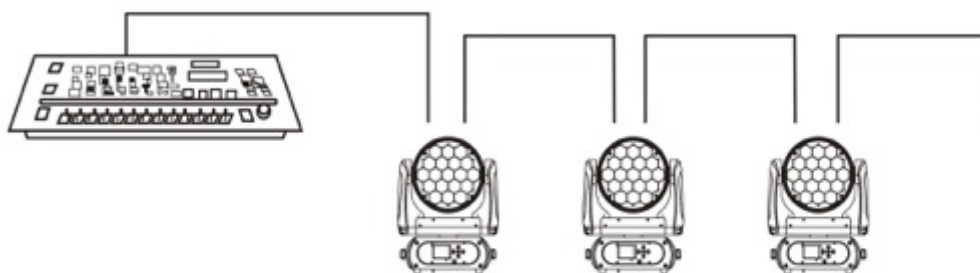

5.2 DMX chart

Channel				name	function	Min DMX	Max DMX
St	Ex	Ba1	Ba2				
1	1	1	1	Pan	Pan Coarse	0	255
	2		2	Pan fine	Pan Fine	0	255
2	3	2	3	Tilt	Tilt Coarse	0	255
	4		4	Tilt fine	Tilt Fine	0	255
3	5	3	5	Mov ment Speed	fastest to Slowest	0	255
	6			Mov ment	Normal	0	15
					Movement With Backout	16	31

				Function	TBD	32	255
4	7			Shutter Function	Normal Shutter Functions	0	15
					Pulse-effect Forward	16	31
					Pulse-effect Reverse	32	47
					Random Strobe	48	63
					TBD	64	255
5	8			Shutter	Normal Shutter Functions		
					Close	0	31
					Strobe Rate (slow to fast)	32	223
					Open	224	255
					Pulse-effect Forward		
					Close	0	31
					Strobe Rate (slow to fast)	32	223
					Open	224	255
					Pulse-effect Reverse		
					Close	0	31
					Strobe Rate (slow to fast)	32	223
					Open	224	255
					Random Strobe		
					Close	0	31
					Strobe Rate (slow to fast)	32	223
Open	224	255					
		4	6	Shutter	Shutter closed	0	31
					No function (shutter open)	32	63
					Strobe effect slow to fast	64	95
					No function (shutter open)	96	127
					Pulse-effect in sequences	128	159
					No function (shutter open)	160	191
					Random strobe effect slow to fast	192	223
					No function (shutter open)	224	255
6	9	5	7	Dimmer	Dimmer(0->100%)	0	255
7	10	6	8	Virtual Color Function	On Function	0	15
					CTC Function	16	31
					Forward Spin	32	47
					Reverse Spin	48	63
					Continuous	64	79
					Color Bounce	80	111
					TBD	112	255
8	11	7	9	Virtual Color 1	CTC Function		
					Colour Temperature Correction 2000K->2700K	0	223
					White 3200K	224	231
					White 4200K	232	239
					White 5600K	240	247
					White 8000K	248	255

					Forward Spin		
					Rainbow Effect (Slow->Fast)	0	255
					Reverse Spin		
					Rainbow Effect (Slow->Fast)	0	255
					Continuous & Color Bounce		
					Black	0	0
					Red	1	1
					Green	2	2
					Blue	3	3
					White	4	4
					Red=0, Green->up,Blue=full,White=0	5	46
					Red=0, Green=full,Blue->down,White=0	47	88
					Red->up, Green=full,Blue=0,White=0	89	130
					Red=full, Green->down,Blue=0,White=0	131	172
					Red=full, Green=0,Blue->up,White=0	173	214
					Red->down, Green=0,Blue=full,White=0	215	255
9	12	8	10	Virtual Color 2(Only On Color Bounce)	Color Bounce		
					Black	0	0
					Red	1	1
					Green	2	2
					Blue	3	3
					White	4	4
					Red=0, Green->up,Blue=full,White=0	5	46
					Red=0, Green=full,Blue->down,White=0	47	88
					Red->up, Green=full,Blue=0,White=0	89	130
					Red=full, Green->down,Blue=0,White=0	131	172
					Red=full, Green=0,Blue->up,White=0	173	214
					Red->down, Green=0,Blue=full,White=0	215	255
10	13	9	11	Red-All	Red 0->100%	0	255
11	14	10	12	Green-All	Green 0->100%	0	255
12	15	11	13	Blue-All	Blue 0->100%	0	255
13	16	12	14	White-All	White 0->100%	0	255
14	17	13	15	Zoom	small angle -> Big angle	0	255
15	18	14	16	Foreground	No Function	0	15
					Foreground Color	16	255
16	19	15	17	Background	No Function	0	15
					Background color	16	255
17	20	16	18	Pattern	On Pattern	0	15
					Pattern control	16	31
					Pattern Effect 1~14	32	255
18	21	17	19	Patte	Pattern control		

				rn	Picture Effect 1-250	3	252
				Spee	Pattern Effect		
				d	Slow-> Fast	0	255
	22			Red	Led Off	0	127
				Pixel	Led On	128	255
				1			
	23			Green	Led Off	0	127
				Pixel	Led On	128	255
				1			
	24			Blue	Led Off	0	127
				Pixel	Led On	128	255
				1			
	25			White	Led Off	0	127
				Pixel	Led On	128	255
				1			
	:						
	94			Red	Led Off	0	127
				Pixel	Led On	128	255
				19			
	95			Green	Led Off	0	127
				Pixel	Led On	128	255
				19			
	96			Blue	Led Off	0	127
				Pixel	Led On	128	255
				19			
	97			White	Led Off	0	127
				Pixel	Led On	128	255
				19			
19	98	18	20	Contr ol	Normal	0	7
					Reset All	8	15
					Pan&Tilt Reset	16	23
					TBD	24	47
					Other Reset	48	55
					Display Off	56	63
					Display On	64	71
					TBD	72	79
					TBD	80	87
					Hibernation	88	95
					TBD	96	255

6. Unique Features

6.1 RDM, stand for "Remote Device Management", with this function, users can realize remote control of the device,

such as remotely changing DMX address, reverse pan/tilt setting, check a lot of useful information such as temperature, power consumption, fan speed. Etc. Every single device has a unique RDM code before left factory to distinguish from each other, usually not suggest users change this code freely.

6.2 Software upgrade function via DMX cable, if there is any new firmware for this device come out, it can be upgraded simply via a software upgrade box, no need to change any mechanical parts. The upgrade box is not included in the package, if need any further assistance pls just contact authorized dealers.

6.3 Hibernation, the device will enter sleeping mode if activated after a period of disconnecting DMX signal to save the power consumption, and will return immediately as soon as the DMX signal is sent again.

6.4 Display back-up communication IC, there is a back-up communication IC installed in the display PCB, so users could replace at once if the working one is broken, no need to wait long time from service.

6.5 Display flip, by press up and down button for more than 3 seconds, the display will flip automatically, this function is useful to read menu conveniently when device is hanged.

7. Dimensions Drawing

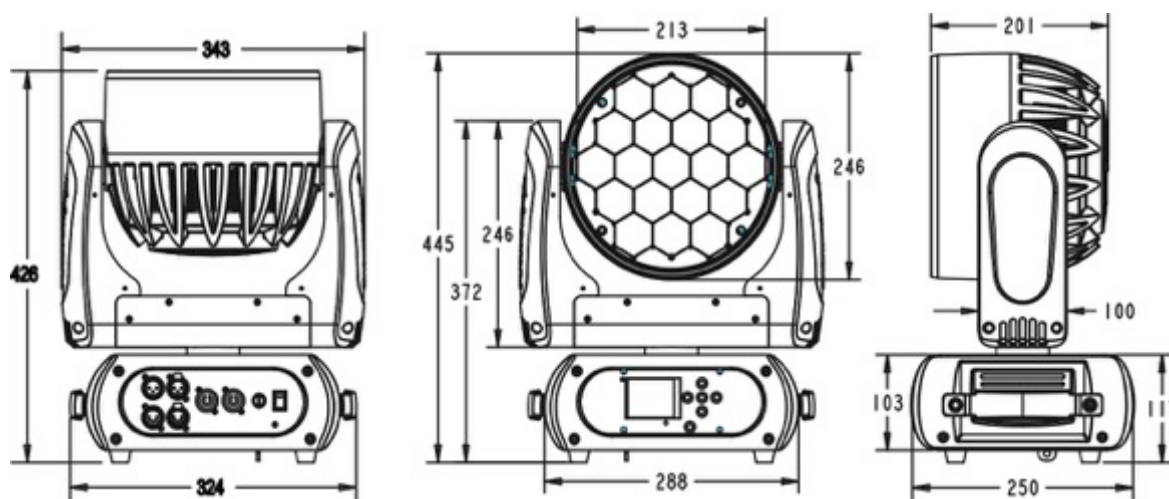

8. Technical specification

Power supply	100-240 V AC, 50/60 Hz ~
Power consumption	316W(input), 280W(output)
LED	19pcs OSRAM 15W 4in1 leds
DMX channels	19/98/18/20 modes
Beam angle	6° to 65°
Luminous flux	8000lumen, 21880lux@3m at 6°, 1600lux@3m at 65°
Fuse	T 3.15 A, 250 V
Device dimensions	344x250x445mm
Net Weight	12KG